

ISOTOP® SANDWICH ELEMENTS

DATASHEET



Quickly find the right Isotop® machine bearing for your application with the EquipCalc selection program from Getzner.



Register online now
apps.getzner.com

PRODUCT BENEFITS

- High structural strength despite light weight due to a combination of rigid pressure distribution plates and lightweight isolating layers
- Exceptional acoustic insulation properties - ideal for applications where sound control is important
- Easy to install, low maintenance requirements and hence lower operating costs

All information and data are based on our current knowledge. It can be used in calculations and for reference purposes, but is subject to product-specific and application-specific manufacturing tolerances and does not represent warranted properties. Material properties and their tolerances vary depending on the type of application and load and are available from Getzner on request. Subject to change without notice.

For further general information, see VDI Directive 2062 and glossary.
Further characteristic values available on request.

getzner

ISOTOP® SE PRO



Isotop® type overview

Static application range

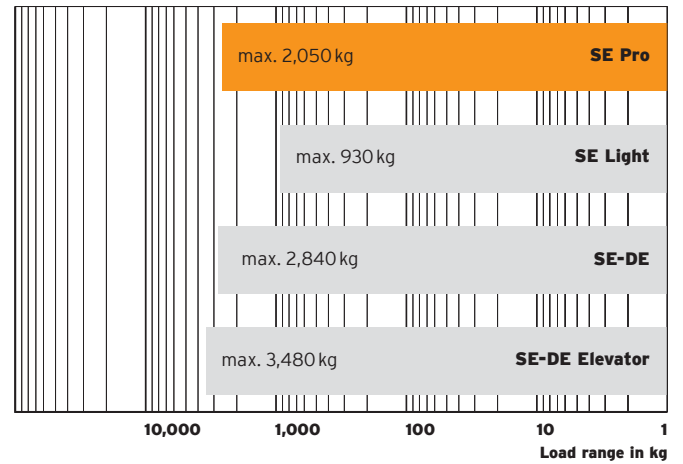

Description

Category	Sandwich element
Material	4 mm Sylomer® anti-slip plate 10 mm steel pressure plate 37.5 mm Sylomer® / Sylodyn® isolating layer
Dimensions	51.5×150×150 mm

Product characteristics

Natural frequency from	7.5 Hz
Load range	0-2,050 kg / 20,111 N
Overall height, unloaded	51.5 mm
Connection thread	M12 internal thread
Coating	Hot dip galvanised
Permissible temperature range	-30°C to +70°C
Suitable accessories	Pre-mounted base plate on request



[getzner.com/
sandwich-pads](https://www.getzner.com/sandwich-pads)

by getzner
isotop®

Isotop® SE Pro

(unloaded)

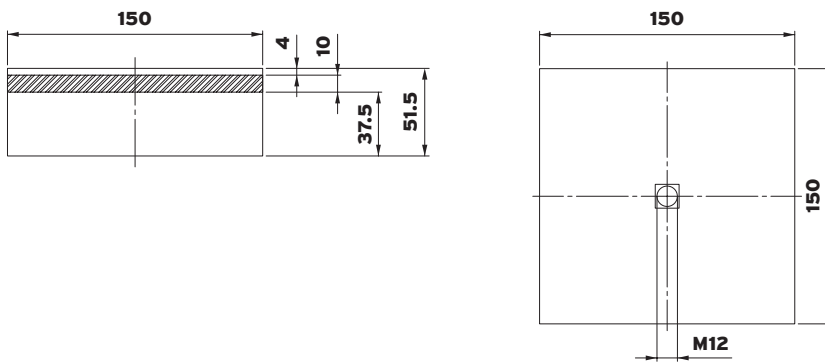
**Isotop® SE Pro with base plate**

(unloaded)

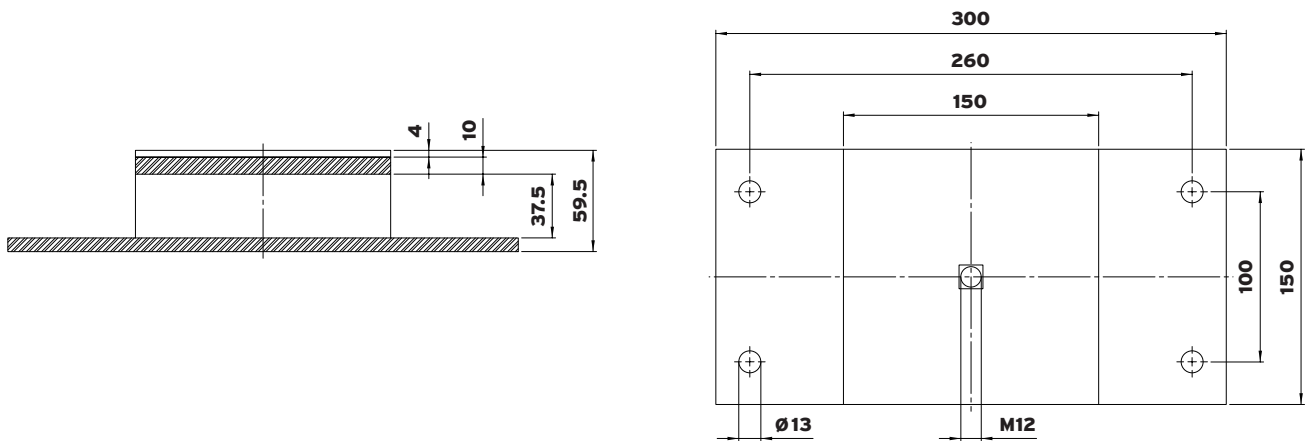

Isotop® SE Pro 9-1

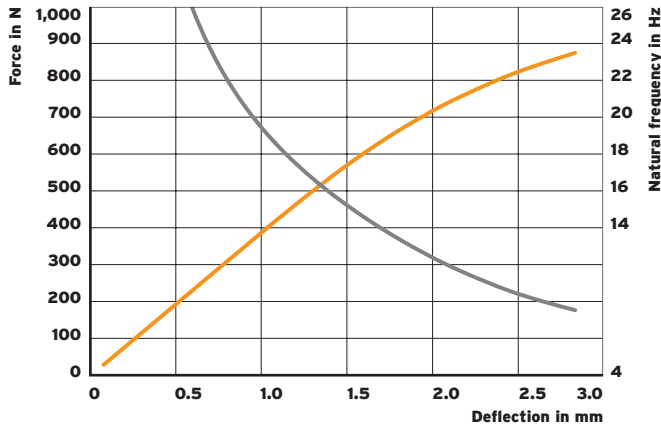

Isotop® SE Pro 14-1

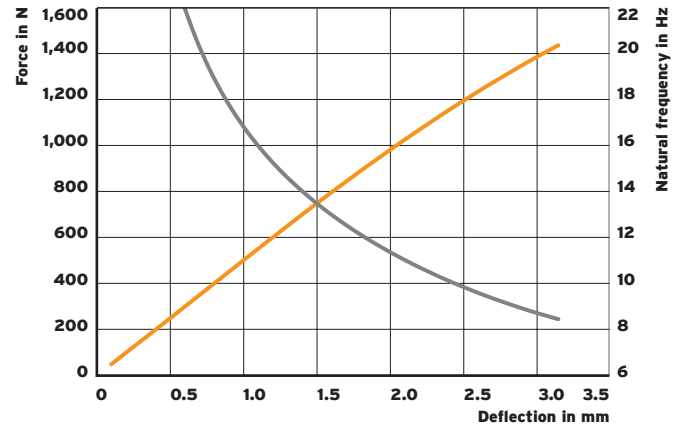

Isotop® SE Pro 28-1

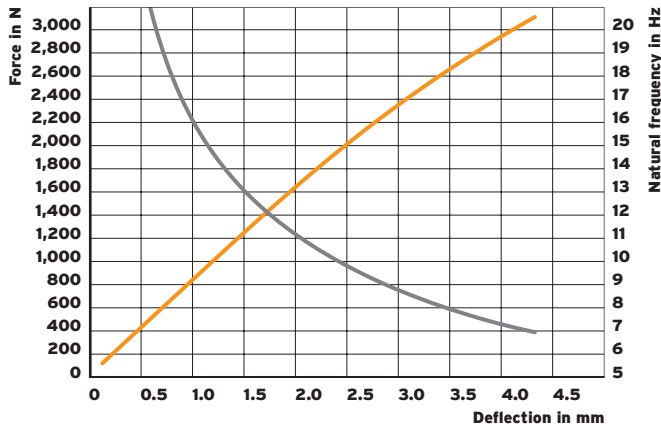

Isotop® SE Pro 67-1

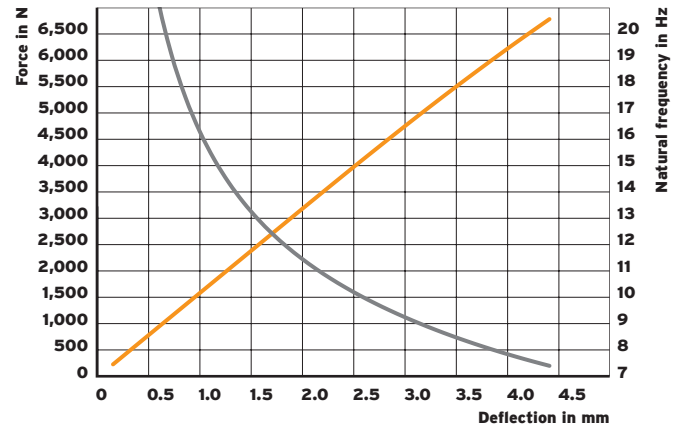

Isotop® SE Pro 133-1

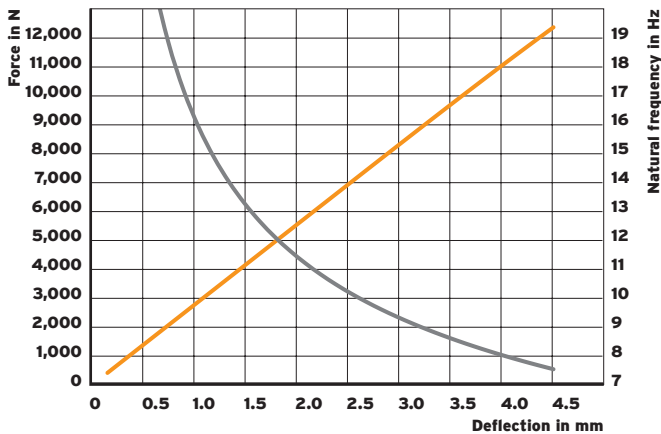

Isotop® SE Pro 225-1

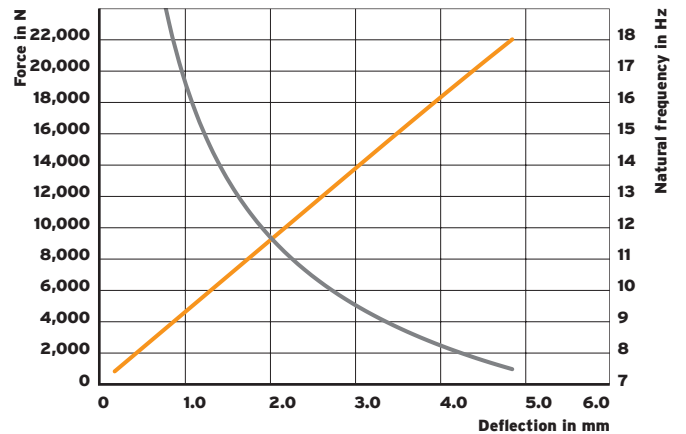

— Force in N
— Natural frequency in Hz

ISOTOP® SE LIGHT



Isotop® type overview

Static application range

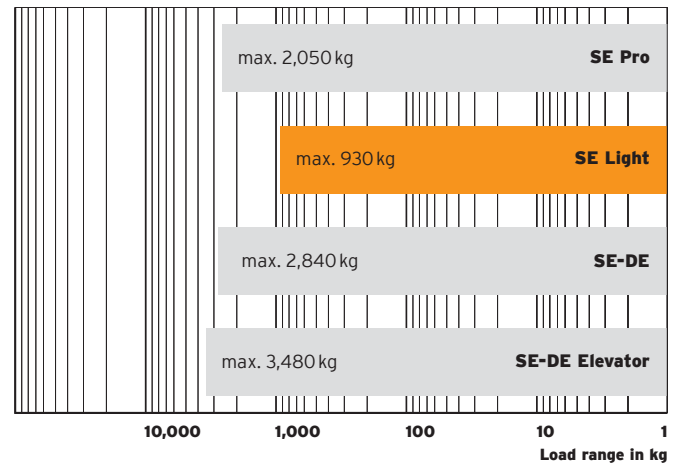

Description

Category	Sandwich element
Material	3 mm Sylomer® anti-slip plate 5 mm steel pressure plate 25 mm Sylomer® isolating layer
Dimensions	33×150×150 mm

Product characteristics

Natural frequency from	10.8 Hz
Load range	0-930 kg / 9,123 N
Overall height, unloaded	33 mm
Connection thread	–
Coating	feuerverzinkt
Permissible temperature range	-30 °C bis +70 °C
Suitable accessories	–

Isotop® SE Light

(unloaded)

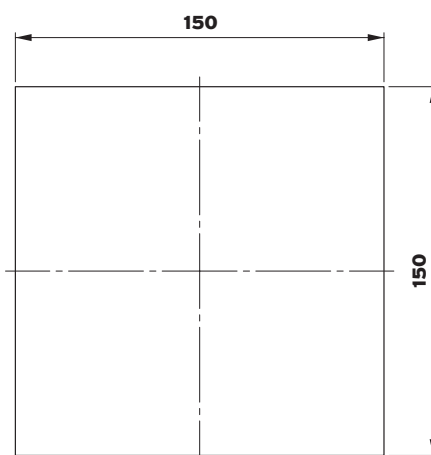
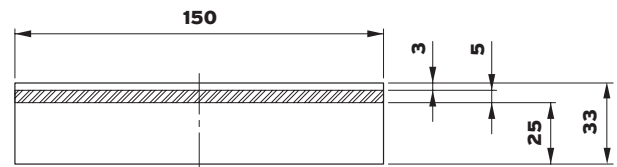

getzner.com/
sandwich-pads

Isotop® SE Light 6-1

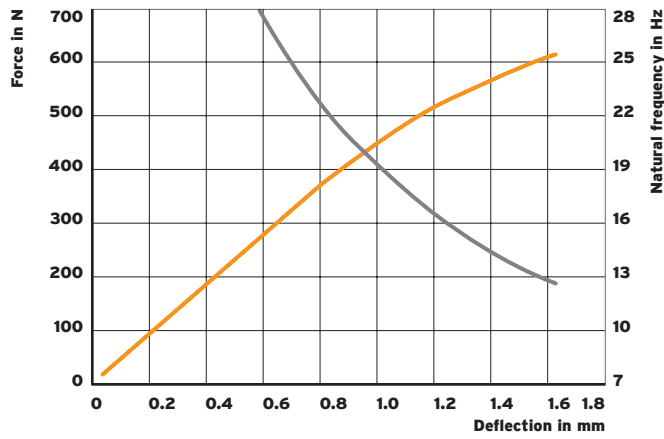

Isotop® SE Light 12-1

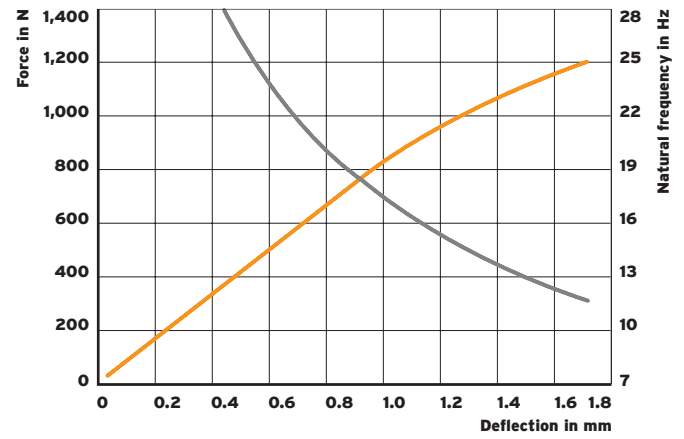

Isotop® SE Light 24-1

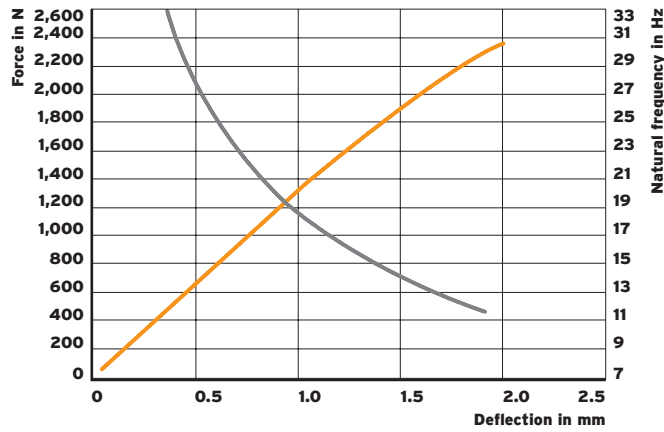

Isotop® SE Light 47-1

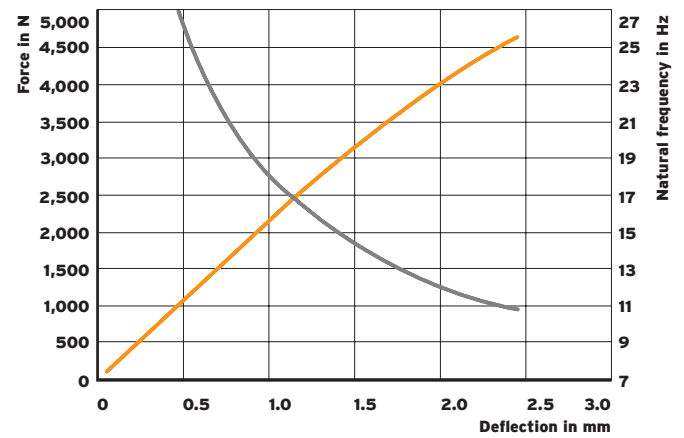

Isotop® SE Light 93-1

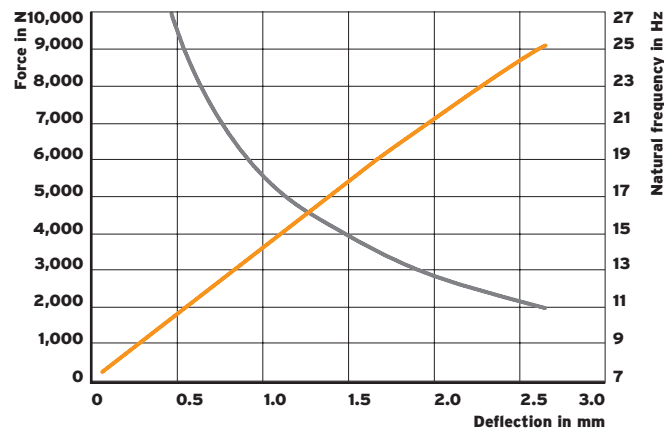

— Force in N
— Natural frequency in Hz

ISOTOP® SE-DE



Isotop® type overview

Static application range

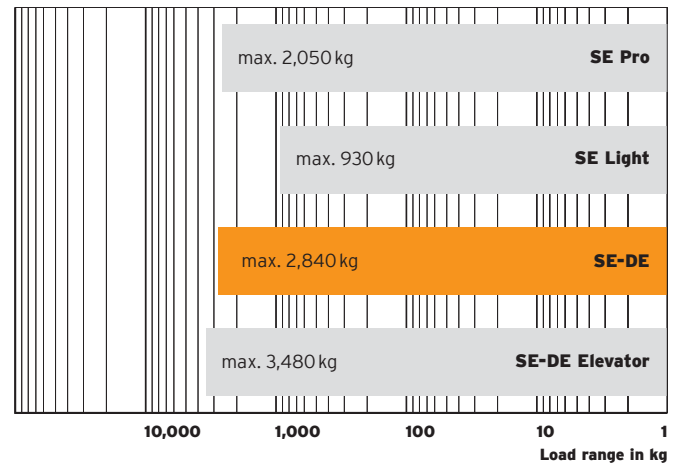

Description

Category	Sandwich element Category EL-3 according to DIN 8989 (VDI 2566)
Material	4 mm Sylomer® anti-slip plate 10 mm steel pressure plate 60 mm settling mass 75 mm Sylomer® / Sylodyn® isolating layer
Dimensions	149×200×150 mm

Product characteristics

Natural frequency from	5.7 Hz
Load range	0-2,840 kg / 27,860 N
Overall height, unloaded	149 mm
Connection thread	M12 internal thread
Coating	Hot dip galvanised
Permissible temperature range	-30°C to +70°C
Suitable accessories	–



[getzner.com/
sandwich-pads](https://www.getzner.com/sandwich-pads)

by getzner
isotop®

Isotop® SE-DE with anti-slip mat
(unloaded)

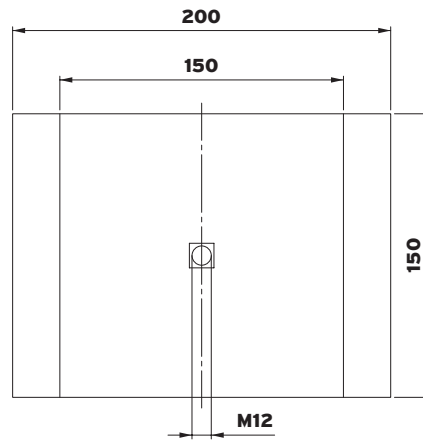
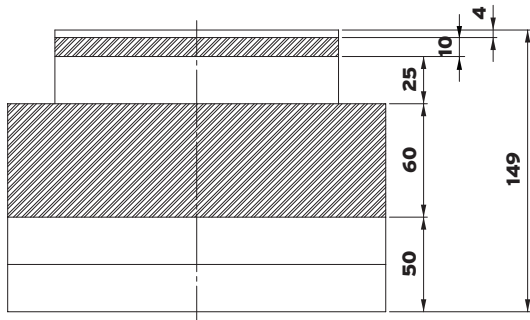

Isotop® SE-DE

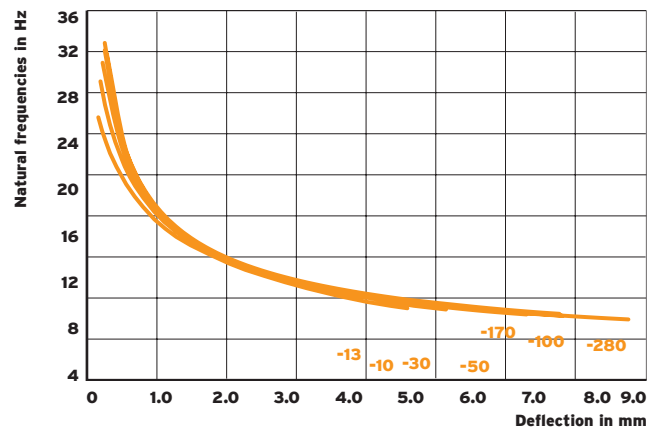
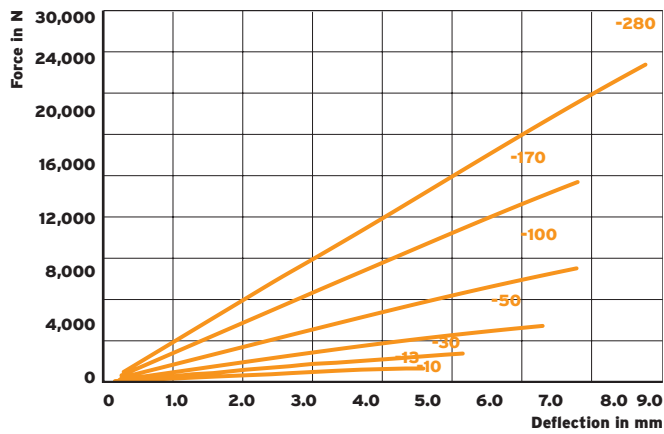

ISOTOP® SE-DE ELEVATOR



Isotop® type overview

Static application range

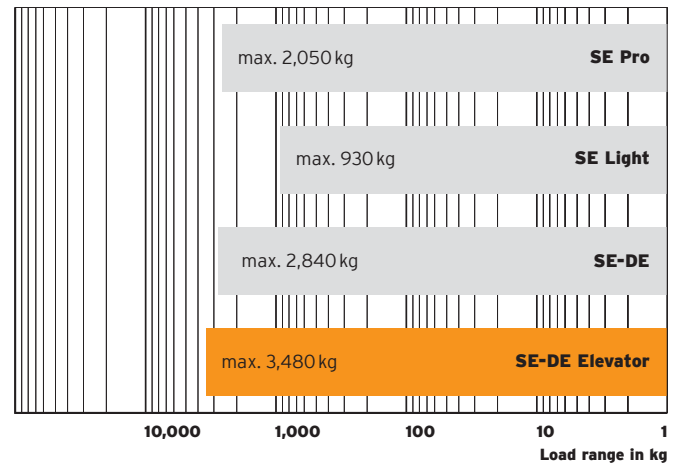

Description

Category	Sandwich element Category EL-3 according to DIN 8989 (VDI 2566)
Material	4 mm Sylomer® anti-slip plate 10 mm steel pressure plate 60 mm settling mass 37 mm Sylomer® / Sylodyn® isolating layer
Dimensions	111 × 200 × 150 mm

Product characteristics

Natural frequency from	8.8 Hz
Load range	0-3,480 kg / 34,138 N
Overall height, unloaded	111 mm
Connection thread	M12 internal thread
Coating	Hot dip galvanised
Permissible temperature range	-30°C to +70°C
Suitable accessories	–



[getzner.com/
sandwich-pads](https://www.getzner.com/sandwich-pads)

by getzner
isotop®

Isotop® SE-DE Elevator with anti-slip mat
(unloaded)

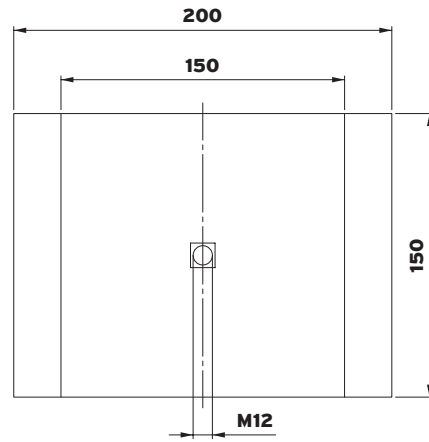
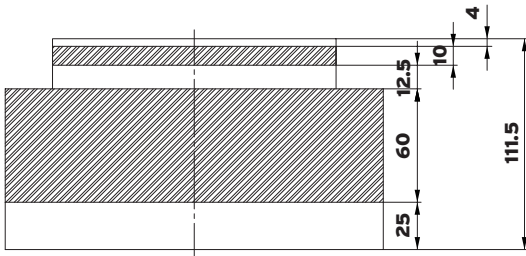

Isotop® SE-DE Elevator

